

Die Küche von Morgen

# Bioküche





# Die Küche von Morgen

## Bioküche





Die Küche von Morgen

# Bioküche





# Bioküche

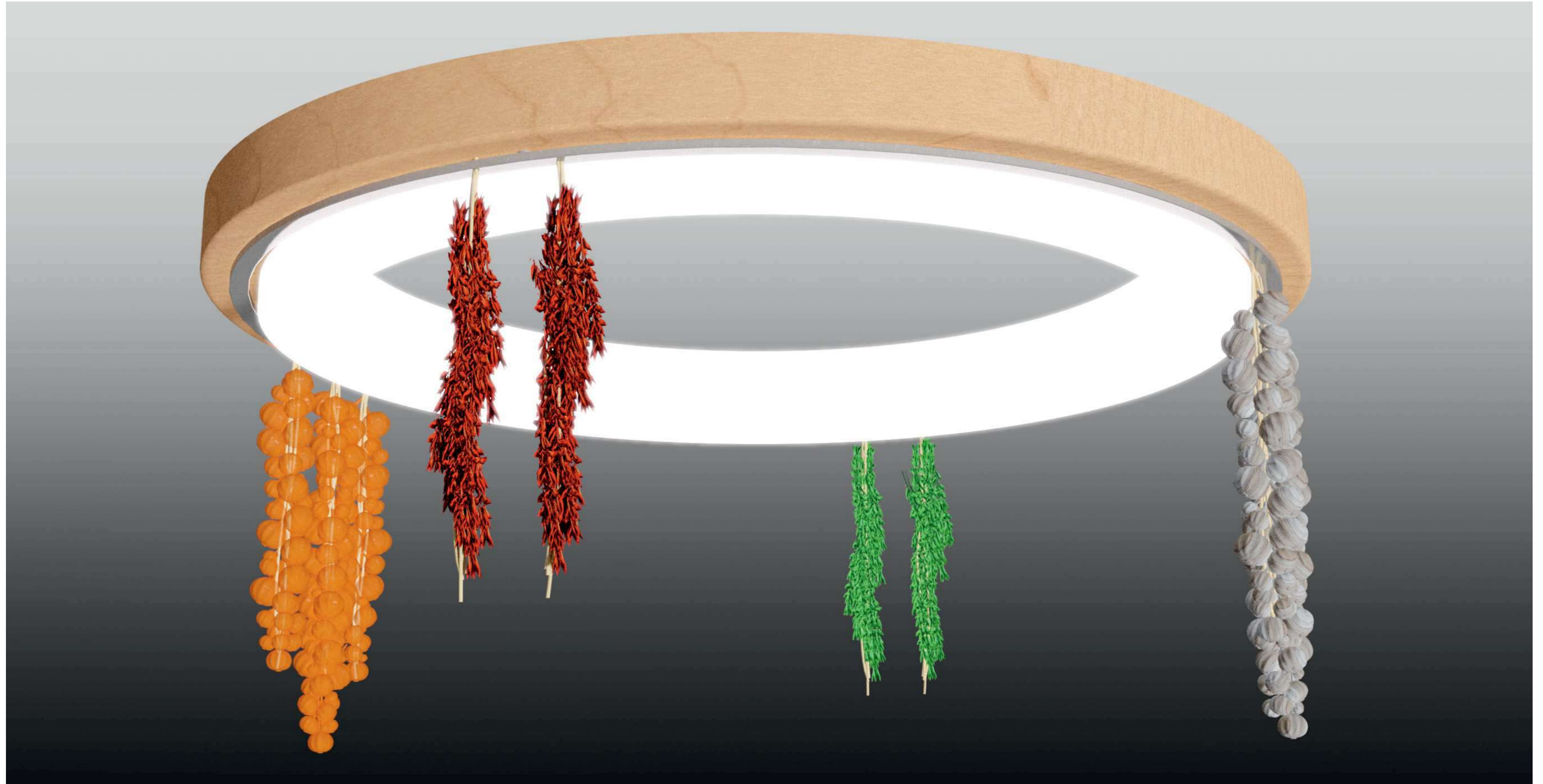



# Bioküche





# Bioküche

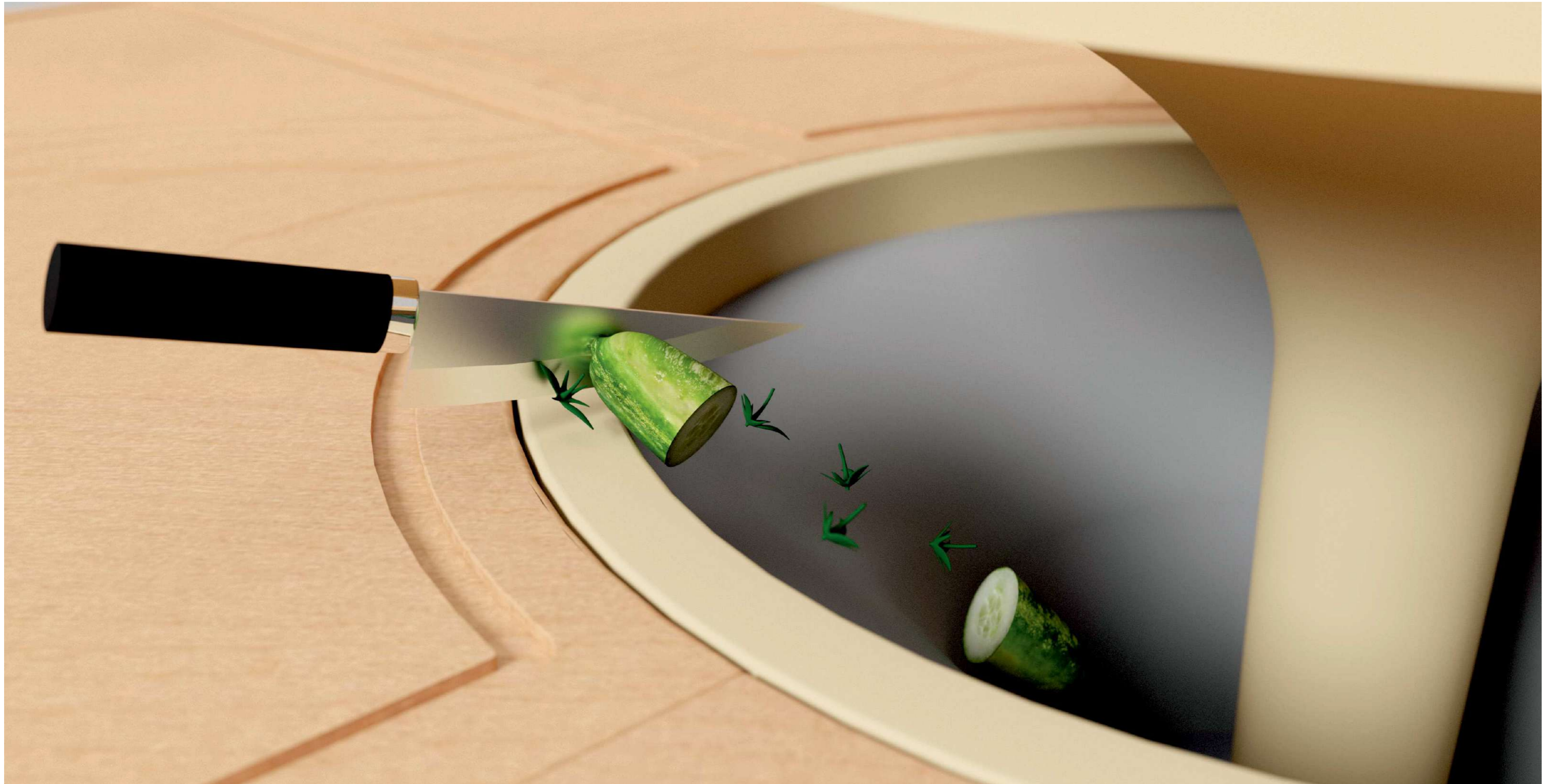



Die Küche von Morgen

# Bioküche





Die Küche von Morgen

# Bioküche





Die Küche von Morgen

# Bioküche







Cleverküche





Cleverküche





Cleverküche





Cleverküche





Cleverküche



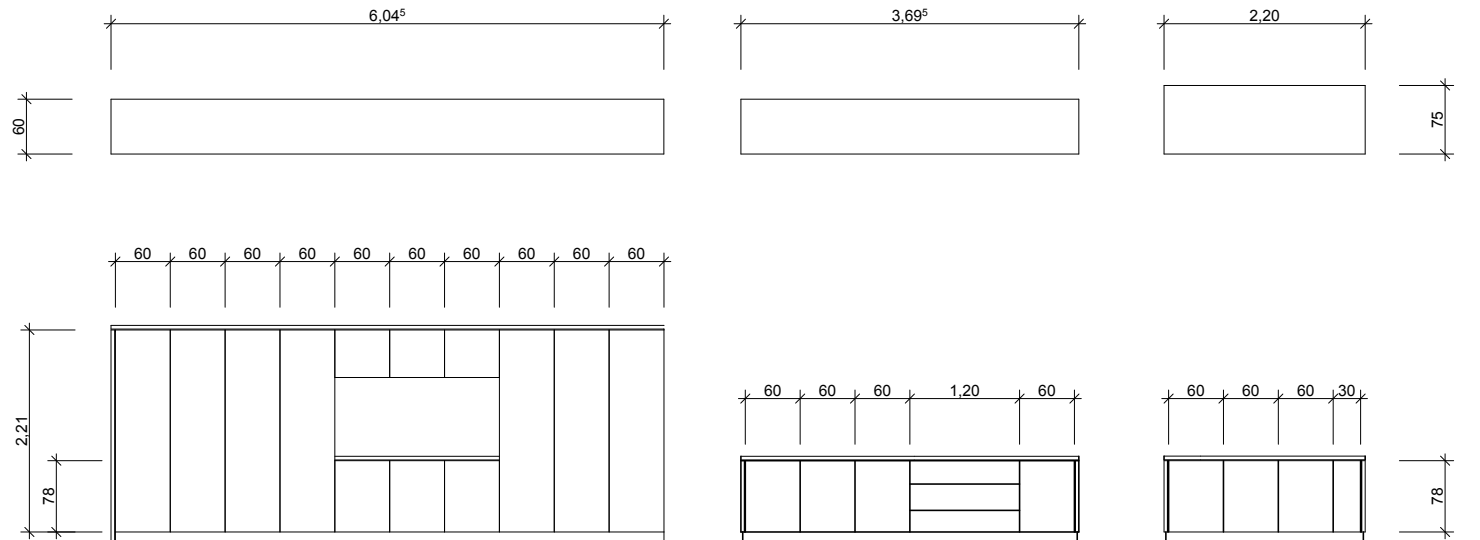

# Cleverküche







Einkaufsliste:

Spinat 500g  
Kopfsalat  
Eisbergsalat  
Brot  
Jogurt  
Kartoffeln 1 kg  
Tomaten  
Mozzarella  
Bergkäse  
Spaghetti 2Pack  
10 Eier  
Fischstäbchen  
Passierte Tomaten  
Tee







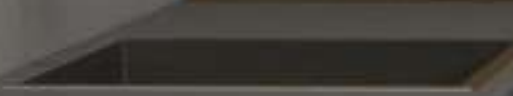



























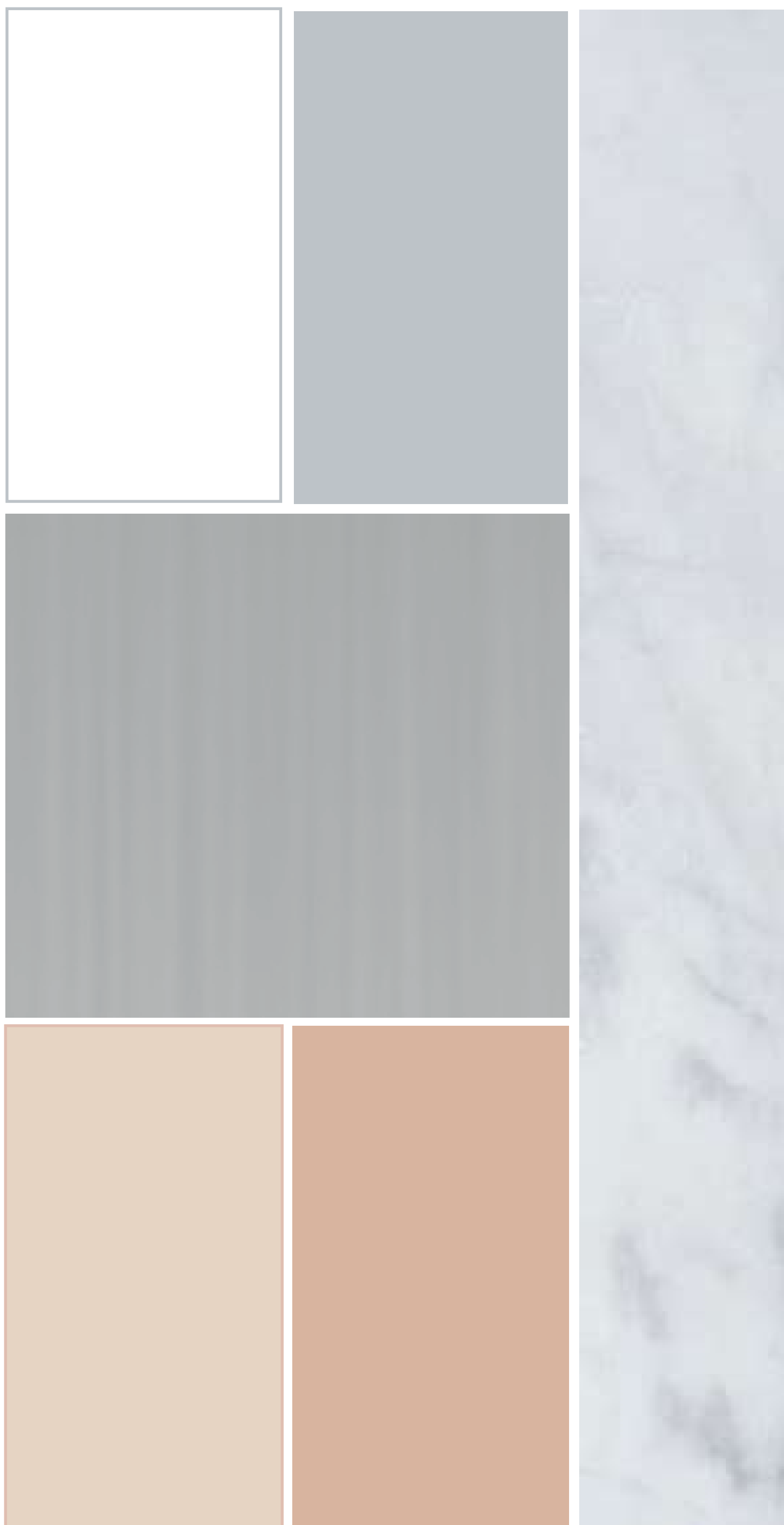







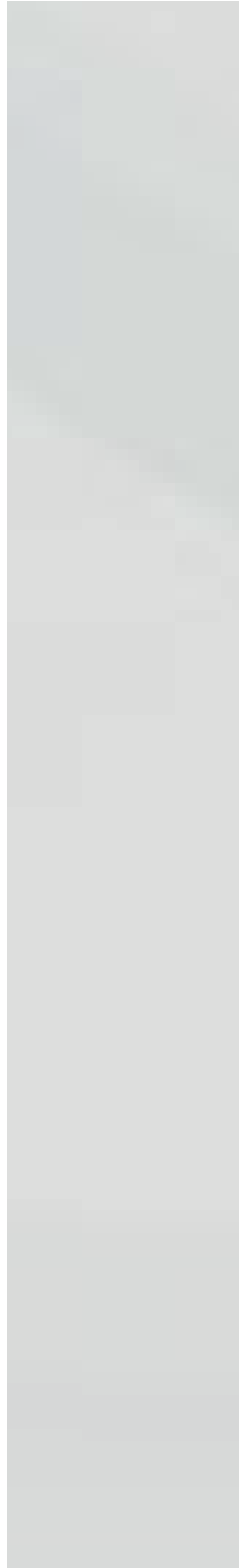











# Die Küche von Morgen

## Genuss Küche





# Genuss Küche

## Küchenaufbau M 1:50

Küchenschrankwand  
6200mm x 2450mm x 600mm

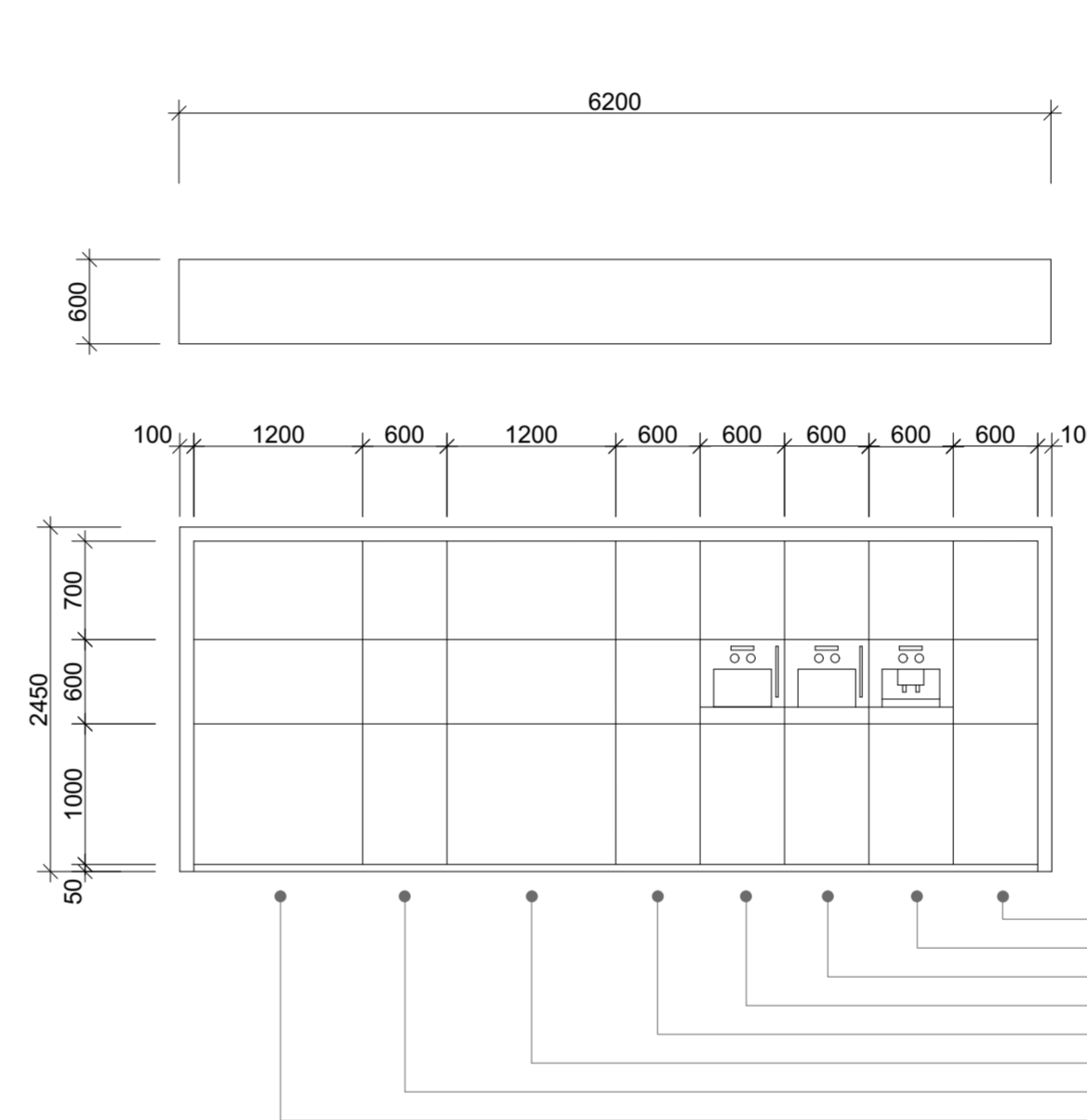
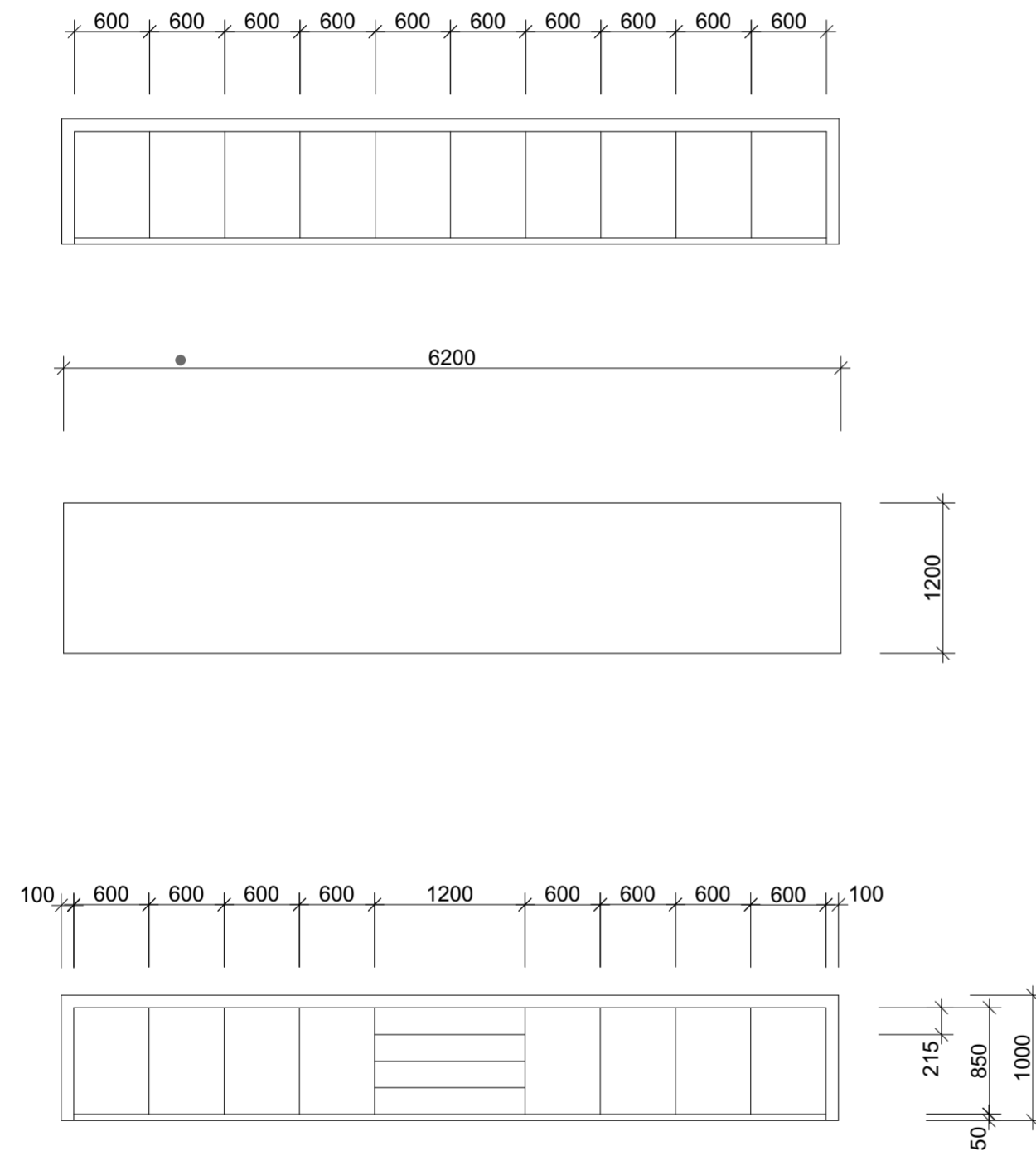

- Hochschrank  
Einflügelig - Schubfächer - Stauraum
- Hochschrank  
Einflügelig - Schubfächer - Stauraum - Kaffeemaschine -  
Warmhalteschubfach - Stauraum
- Hochschrank  
Einflügelig - Schubfächer - Stauraum - Dampfgerar -  
Warmhalteschubfach
- Hochschrank  
Einflügelig - Schubfächer - Stauraum - Ofen
- Hochschrank  
Einflügelig - Schubfächer - Stauraum
- Kühlschrank  
Doppeltür, Einbaugerät
- Weinkühler  
Einflügelig, Einbaugerät
- Fleischschrank  
Doppeltür, Einbaugerät

Kücheninsel  
6200mm x 1000mm x 1200mm

- Schubfächer  
Stauraum
- Unterschrank  
Einflügelig - Schubfächer - Stauraum
- Abfallbehälter  
Ausziehbar
- Geschirrspülmaschine  
Einbaugerät























Wir übernehmen keine Gewähr für eine originalgetreue Darstellung aller Artikel. Farbliche und konstruktive Abweichungen sind möglich. Bei Rückfragen erreichen Sie uns unter 0385 64 64 50 oder [info@ihrekueche.de](mailto:info@ihrekueche.de)

**Grambow & Widmer**

K I C H W E R I N

ihre küche  
Grambow & Widmer GmbH  
Ellerried 7  
19061 Schwerin  
Fachberater: Steffen Widmer

Perspektive  
Angebot 5541/7

16.11.2016

Anja Schaible Stiftung  
Mollenbachstraße 2  
71229 Leonberg



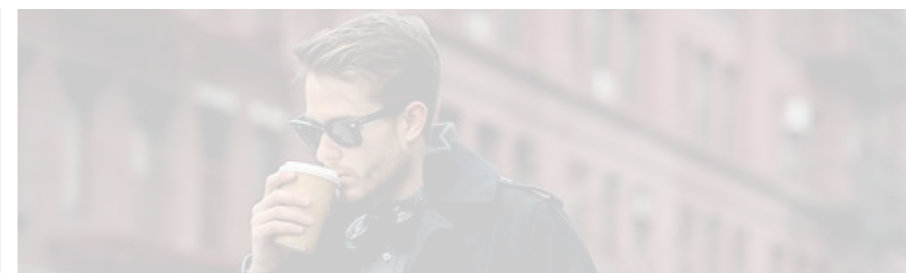
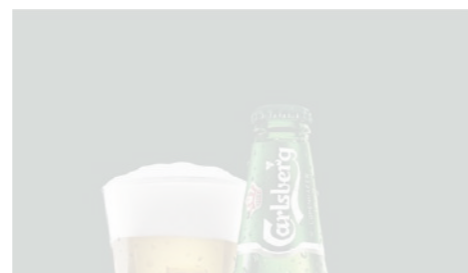
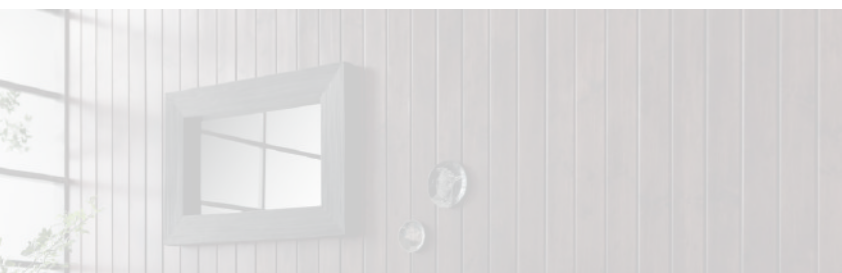
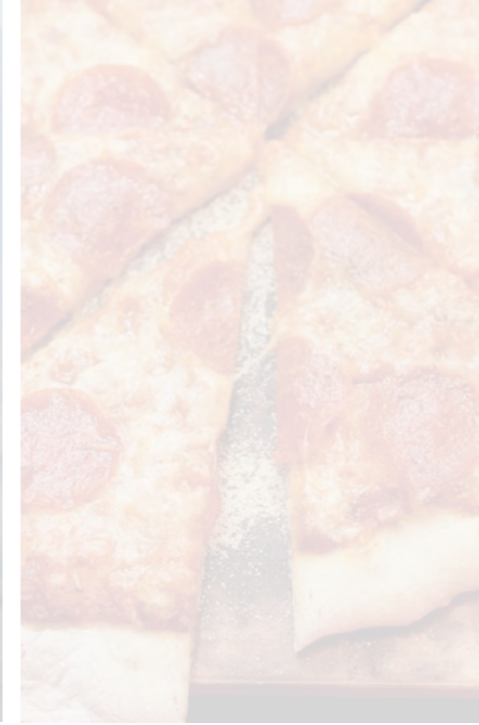

# Lässig Kocher



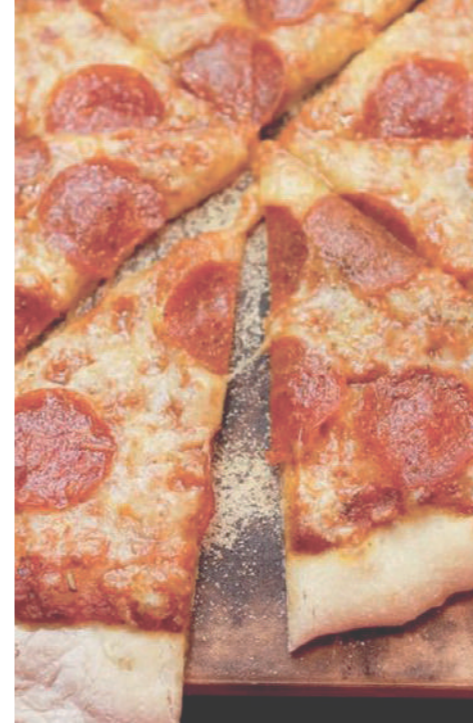





# Lässig Kocher





# Lässig Kocher





# Lässig Kocher





# Lässig Kocher





# Lässig Kocher





# Lässig Kocher





# Lässig Kocher



Die Küche von Morgen

# Lässig Küche





# Die Küche von Morgen

## Lässig Küche

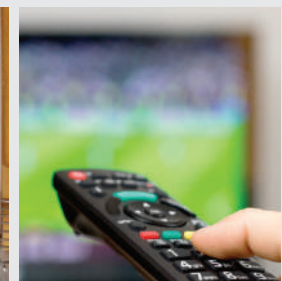



# Lässig Küche

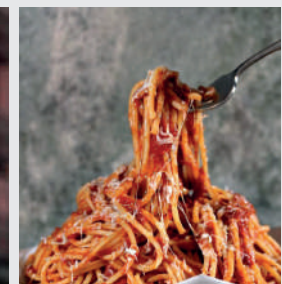
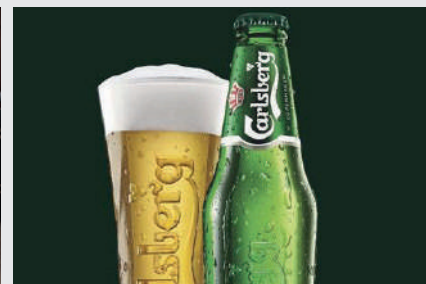
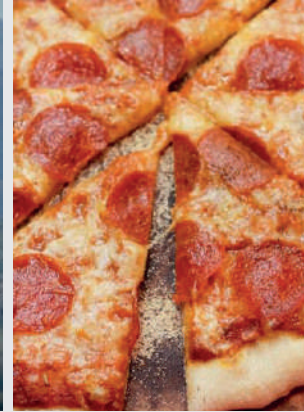



# Lässig Küche

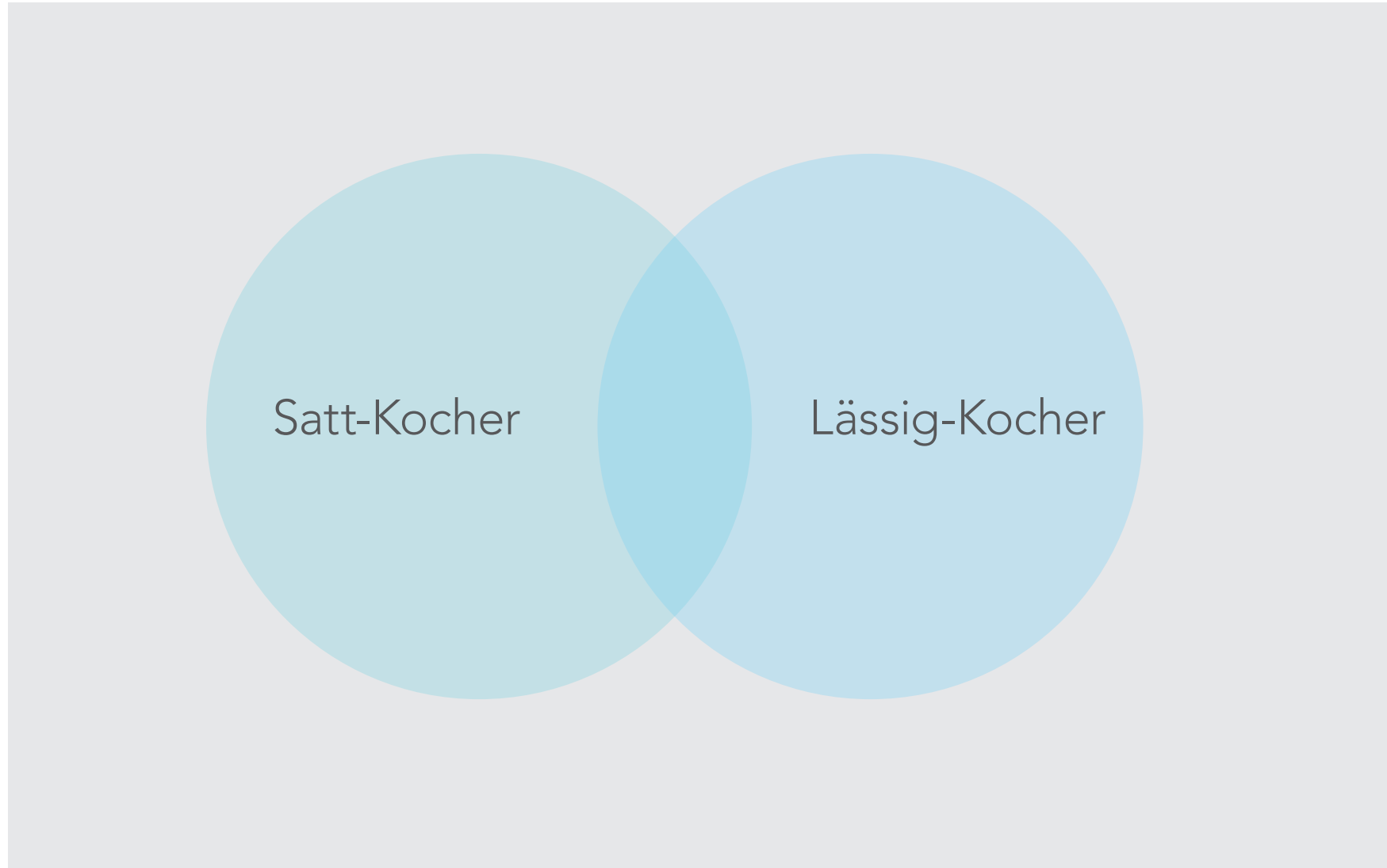



# Lässig Küche

Anspruch des lässig Kochers:

Mobilität

Vielseitige Benutzung

Mehrwert

Flexibilität

hoch moderne Technologie

Anregende Optik

Alleinstellungsmerkmal

Transportfähigkeit

Qualität

Aufmerksamkeitsstärke





Die Küche von Morgen

# Lässig Küche

Basisstation mit mobilem Modul





# Lässig Küche





# Lässig Küche

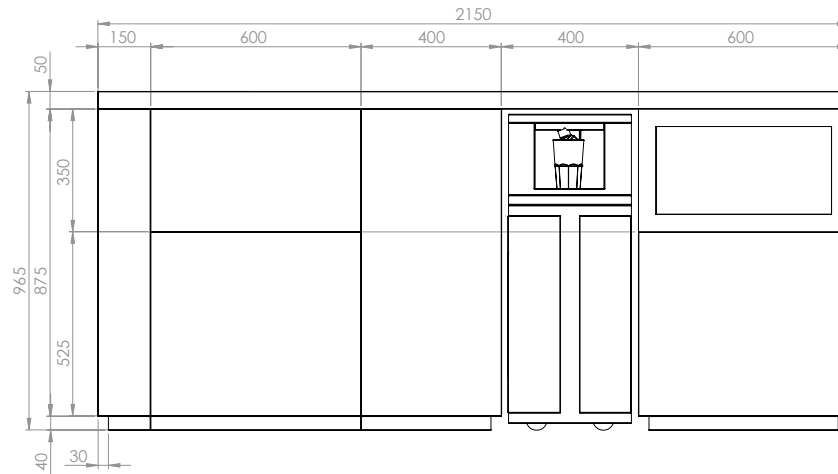
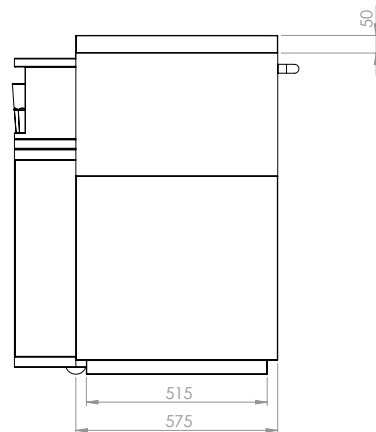
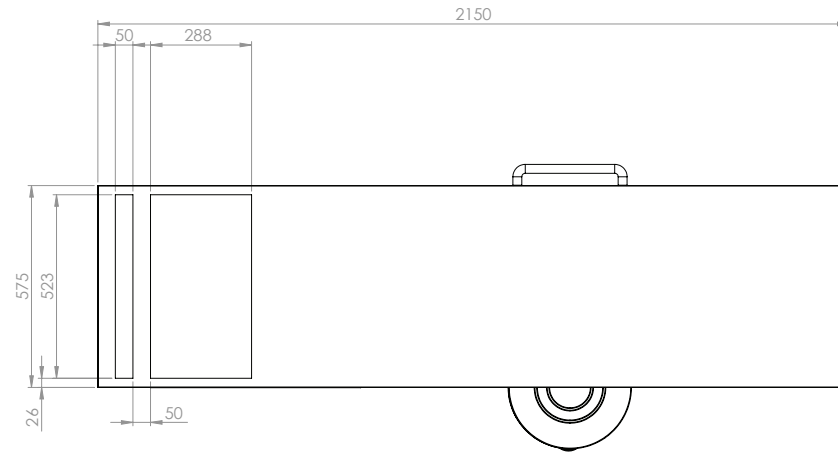
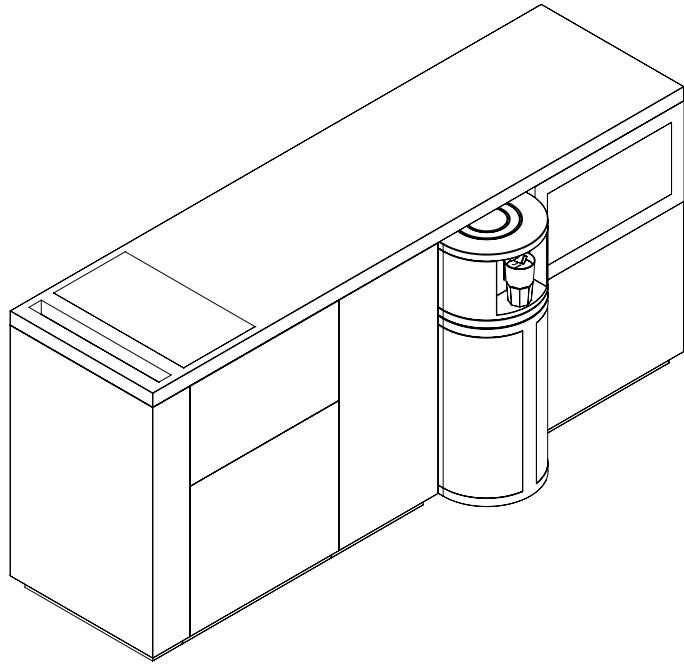



Die Küche von Morgen

# Lässig Küche

mobiler Couch-Caddy (Butler)  
mit schwenkbarem Tischbereich





Die Küche von Morgen

# Lässig Küche





Die Küche von Morgen

# Lässig Küche

mobiler Couch-Caddy (Butler)  
mit schwenkbarem Tischbereich





# Lässig Küche





# Lässig Küche

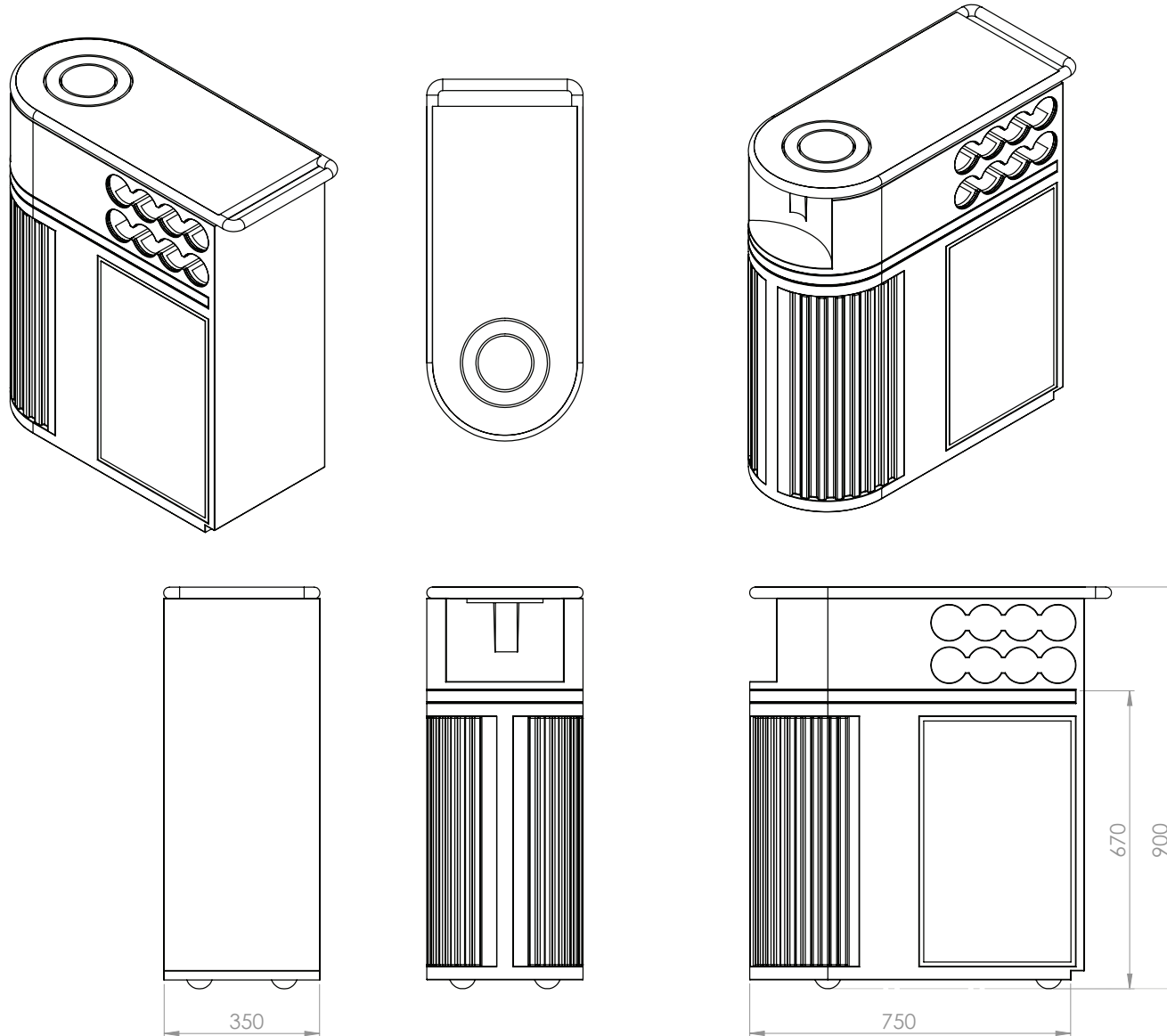



Die Küche von Morgen

# Lässig Küche

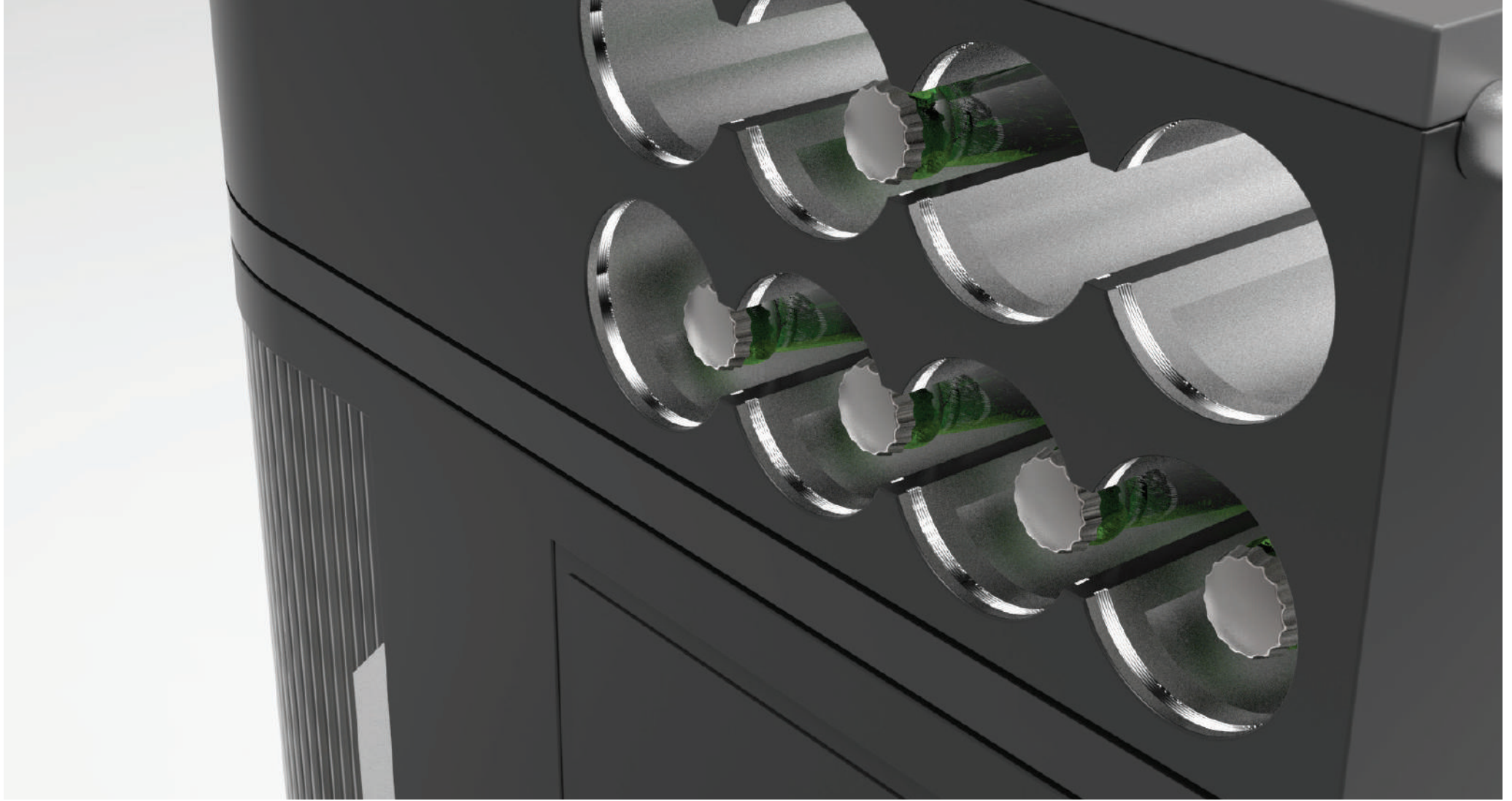



Die Küche von Morgen

# Lässig Küche





Die Küche von Morgen

# Lässig Küche

